

219AW-20 Containers



Suggested yarn:

- Pierrot Yarns Brume [100% wool; 59 yds/54m per 1.4 oz./40g skein];
 - yarn holder:
 - color #03 opal green, 6 skeins [235g]
 - color #09 vanilla beige, 1 skein [35g]
 - small case:
 - color #05 antique rose, 2 skeins [65g]
 - color #09 vanilla beige, 1 skein [15g]

Tools/Notions:

- 6.0mm (US J) crochet hook or size necessary to achieve gauge
- 1 zipper per container (50cm/19.7")
- 4 buttons (23mm/0.9" diameter)

Finished measurements:

- yarn holder:
 - circumference 65.5m/25.8"
 - height 17cm/6.7"
- small case:
 - circumference 42cm/16.5"
 - height 7cm/2.8"

Gauge (10cm/4" square):

- single crochet (US): 11 sts and 9 rounds
- half double crochet (US): 11.5 sts and 12 rounds

Gauge may vary according to individual crochet style. Change hook size if necessary to achieve gauge. Alternatively, rework pattern with your own gauge measurements.

Summary

- ❖ **Note 1:** Like all Japanese patterns, stitch counts given here for foundation chains do not include any chain sts needed for turning posts.
- ❖ **Note 2:** Always hold 2 strands of the same color held together.

Yarn holder lower piece: Work magic ring to begin, then work hdc in the round. Work edging in the round.

Yarn holder upper piece: ch8 to begin and join into the round. Work upper piece the same as lower piece except that you should work holes for the yarn where indicated on upper piece chart.

Yarn holder insert: Work foundation chain to begin, then work in pattern stitch. After binding off, join yarn to foundation chain and work second half of insert. Work edging in the round, including loops.

Small case piece (make 2): Work magic ring to begin, then work sc in the round followed by crab stitch.

Finishing: Sew buttons to lower piece of yarn hold as indicated. Whipstitch yarn holder and small case pieces, respectively, using whipstitch where indicated on finishing schematics. Insert zippers into each item. Place insert inside lower piece of yarn holder with its wrong side facing up and fasten in place.

Abbreviations:

ch = chain hdc = half double crochet (US) m = magic ring/circle rep = pattern repeat(s) RS = right side sc = single crochet (US) WS = wrong side

Yarn holder: upper & lower pieces (make 1 of each)

6.0mm hook

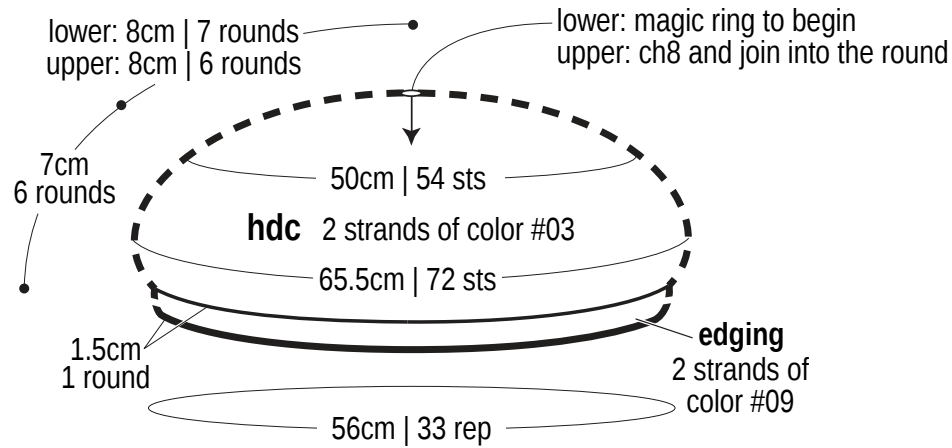

Small case (make 2)

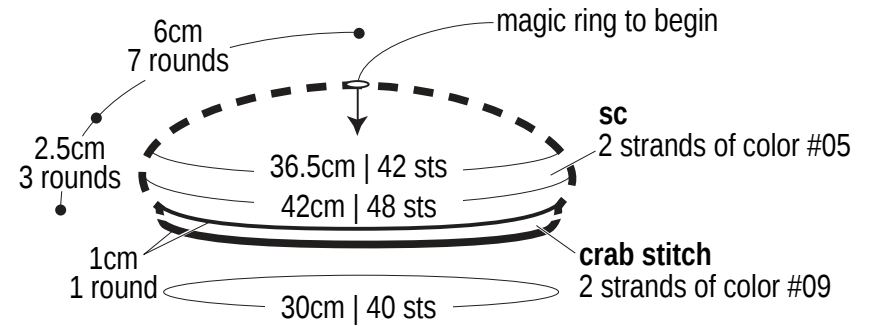

Yarn holder insert

6.0mm hook, 2 strands of color #03

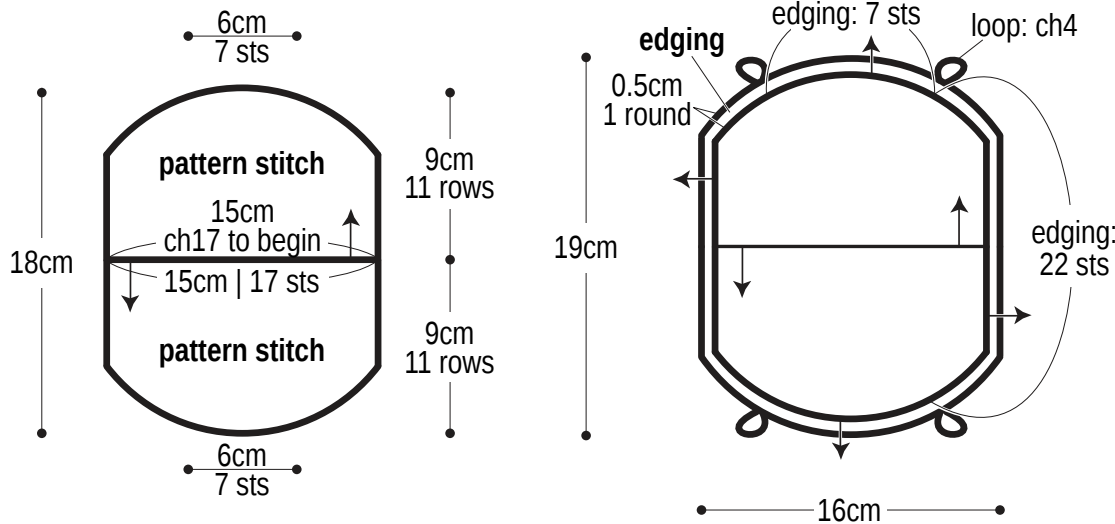

Yarn holder insert

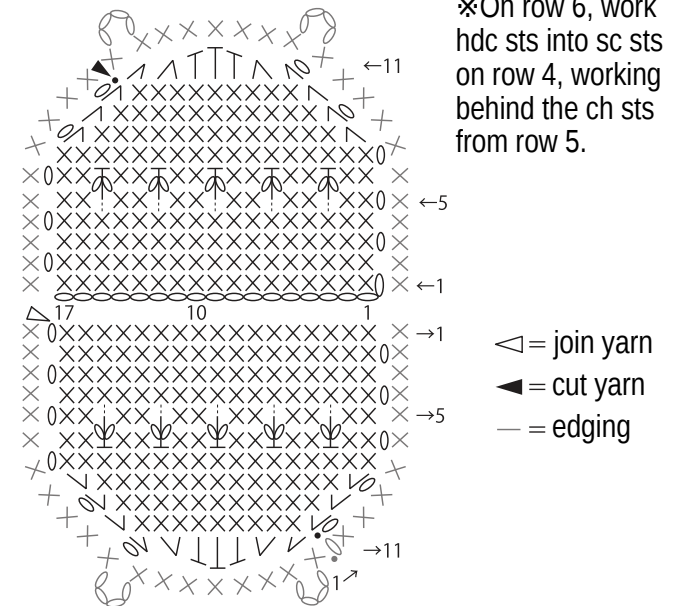

Yarn holder: lower

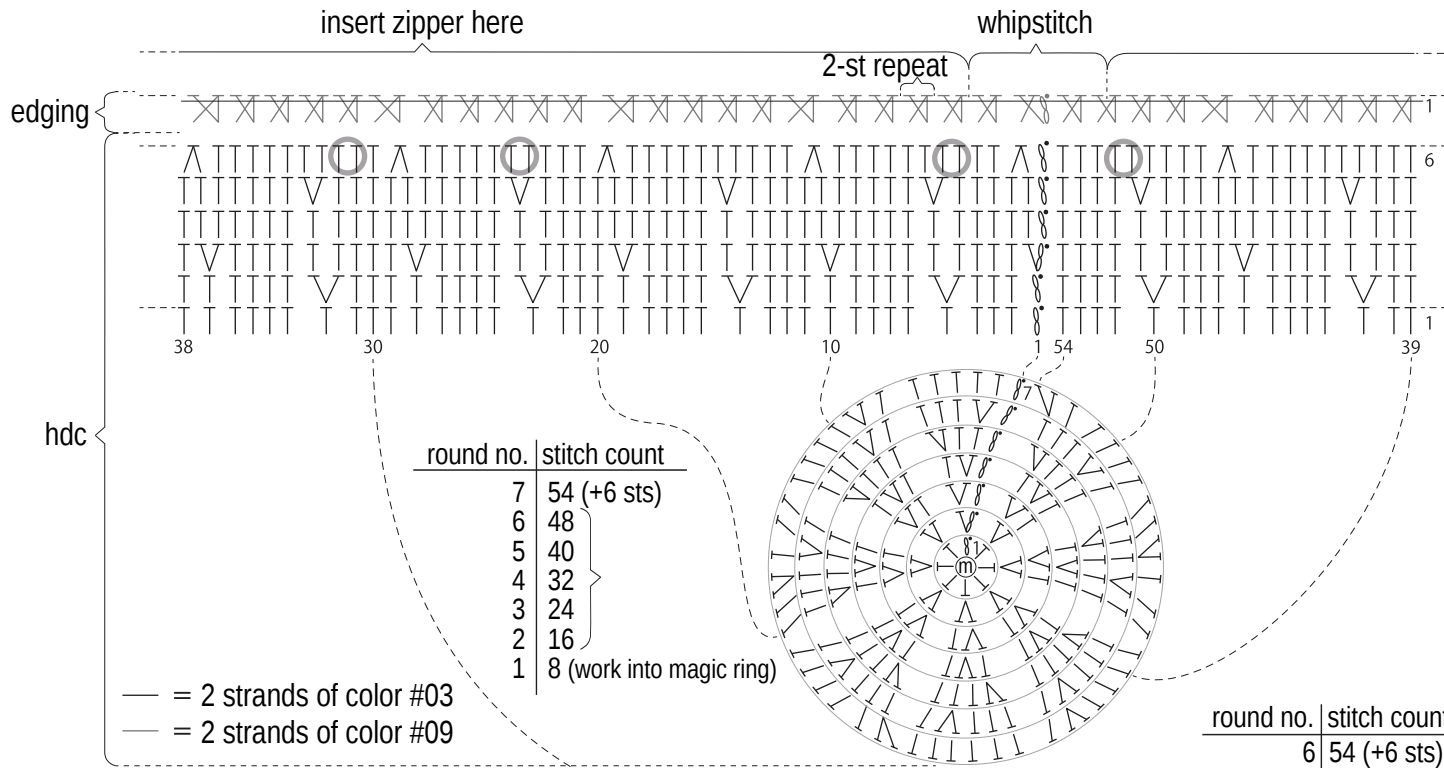

○ = attach button here

round no.	stitch count
6	66 (-6 sts)
5	72 (+6 sts)
4	66 (work even)
3	66
2	60
1	54

} +6 sts per round

Yarn holder: upper

*Rest of upper is identical to lower.

■● = hole for yarn

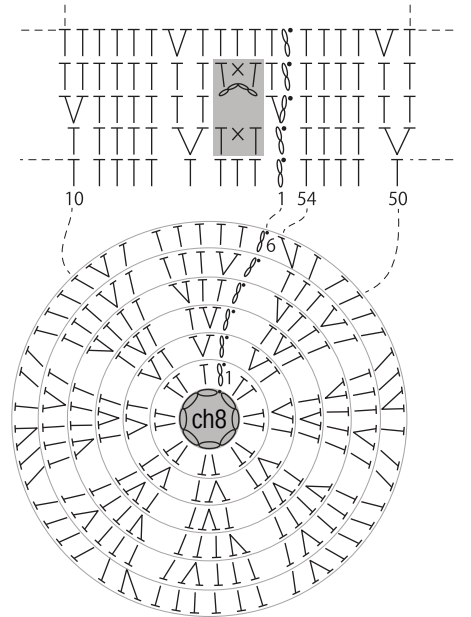

Small case (make 2)

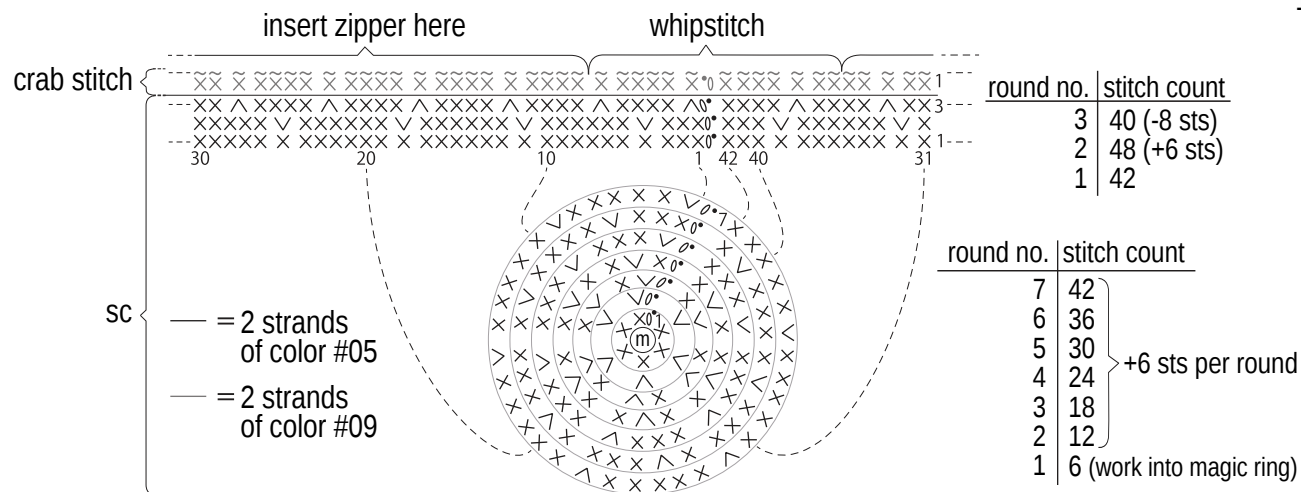

⌘ = crab stitch

Use QR code on smartphone to view a video tutorial about how to work crab stitch.



Finishing

Yarn holder ※Refer to chart/schematic for details locations.

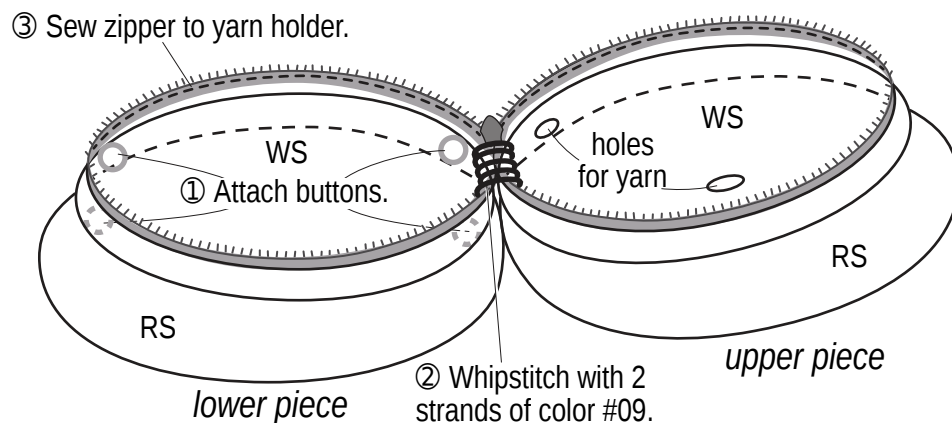

- ① Sew buttons to wrong side of lower piece where indicated.
- ② Seam the upper and lower pieces together with whipstitch where indicated.
- ③ Insert zipper (sew one half of zipper to each piece on the wrong side of the edging).
- ④ Place the insert piece inside the lower piece with its WS facing up and secure it in place.

Small case

※Refer to chart/schematic for details locations.

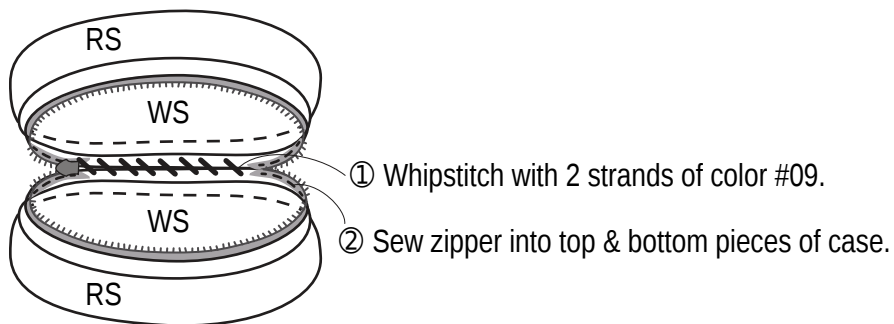

- ① Align the two pieces as shown and seam together using whipstitch.
- ② Insert zipper (sew one half of zipper to each piece on the wrong side of the edging).

