

218aw-19 Hedgehog Tissue Cover



Suggested yarn:

- Pierrot Yarns Fine Merino [100% extra fine merino wool; 103 yds/94m per 1.06 oz./30g skein];
 - color #227 vanilla beige, 2 skeins [60g]
 - color #228 smoke brown, 4 skeins [115g]
 - color #229 brown, 3 skeins [80g]

Tools/Notions:

- 4.0mm (US G) crochet hook or size necessary to achieve gauge
- approximately 30g/1 oz. polyfiber stuffing
- 2 black safety eyes (11.5mm/0.45" diameter)

Finished measurements:

- Please refer to schematics.

Gauge (10cm/4" square):

- No gauge information is provided in the original pattern. Use hook size necessary to achieve desired fabric stiffness.

Summary

❖**Note 1:** Like all Japanese patterns, stitch counts given here for foundation chains do not include any chain sts needed for turning posts.

❖**Note 2:** Entire item worked with 2 strands of yarn held together.

Head: Work magic ring to begin, then work sc in the round. Insert stuffing as you work. After working last round, cut yarn tail & thread through all remaining stitches; cinch top shut.

Front & back paws: Work magic ring to begin, then work sc in the round.

Ears: Work magic ring to begin, then work pattern stitch in the round.

Torso (belly): Work foundation chain to begin, then work in sc in the round, increasing as indicated.

Torso (back): To begin, work pattern stitch in the round into belly piece's foundation chain. Continue working back piece in the round according to chart & schematic (pattern stitch, sc through back loop only, and sc). Insert stuffing as you work. Seam to belly piece by working sts of round 17 of back piece to last round of belly piece.

Finishing: Cut loops of loop sc. Seam ears to head. Fasten safety eyes to head. Seam head, front paws, and back paws to torso. Make fringe & attach to head.

Abbreviations:

ch = chain m = magic ring/circle RS = right side sc = single crochet (US) WS = wrong side

Face 4.0mm hook

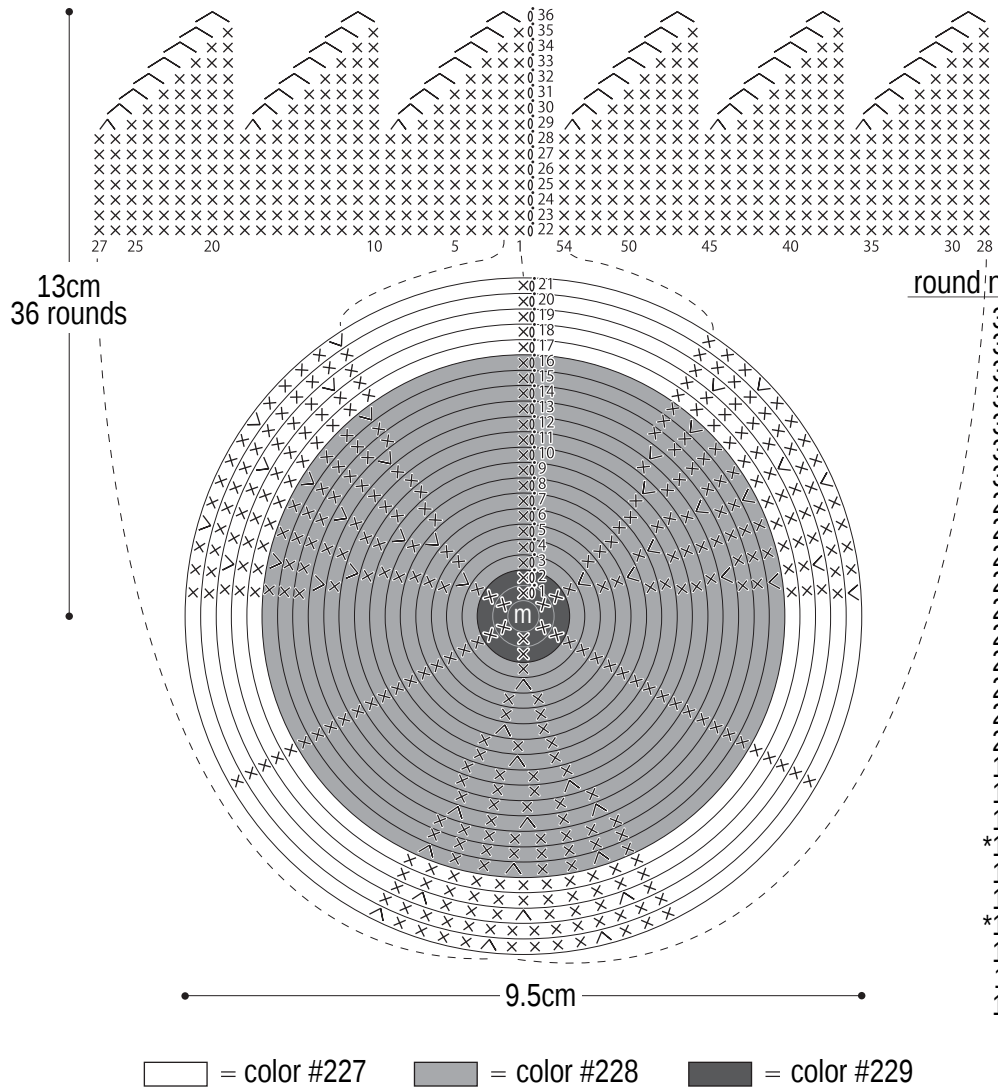

round no.	stitch count	instructions
36	6	
35	12	
34	18	
33	24	-6 sts per round
32	30	
31	36	
30	42	
29	48	
28	54	
27	54	work even
26	54	
25	54	
24	54	
23	54	
22	54	
21	54	+9 sts on odd rounds; work even on even rounds
20	45	
19	45	
18	36	
17	36	
*16	36	+9 sts on rounds marked *; work even all other rounds
15	27	
14	27	
*13	27	
12	18	
11	18	
10	15	+3 sts on odd rounds; work even on even rounds
9	15	
8	12	
7	12	
6	9	work even
5	9	
4	9 (+3 sts)	
3	6	work even
2	6	
1	6 (Work into magic ring.)	

Ear (make 2)

4.0mm hook

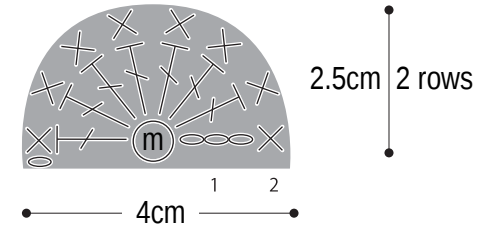

How to finish face

After sewing face/head to body, make fringe (2 strands of yarn 8cm long) and attach to head.

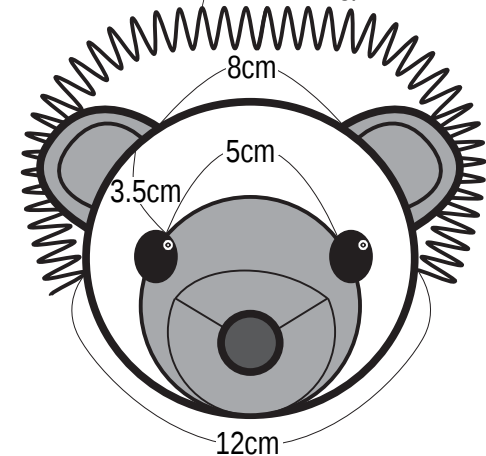

Torso (belly side)

4.0mm hook

※Hold 2 strands together (1 strand of color #228 and 1 strand of color #229).

rounds 9-19

128 sts

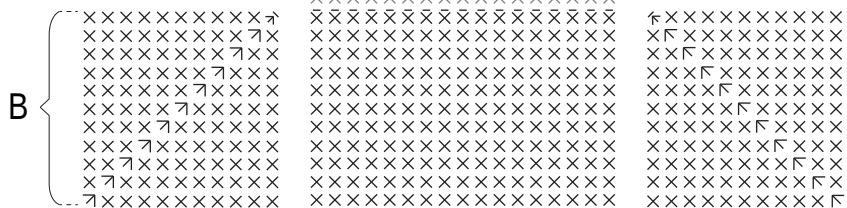
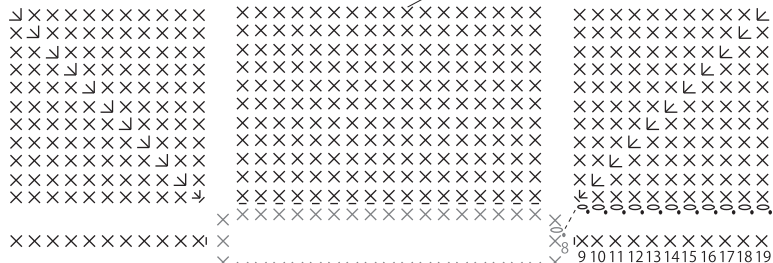

rounds 1-8

rounds 1-8: work even in the round

rounds 9-19: work in the round, increasing as charted

ch40 to begin

Finishing

Cut the center of the loops.

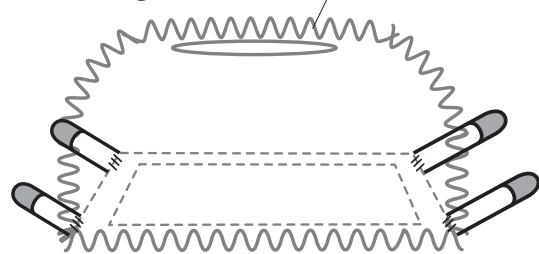

Whipstitch paws to corners of body.

Front paw

make 2
4.0mm hook

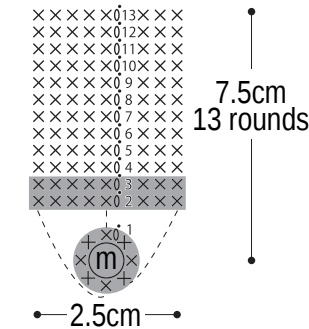

Back paw

make 2
4.0mm hook

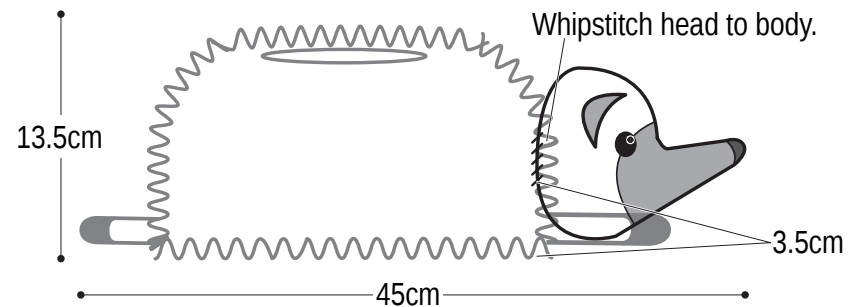
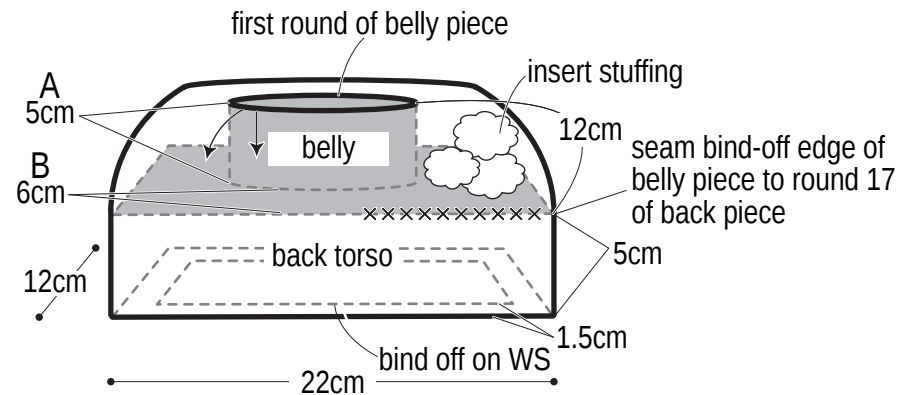
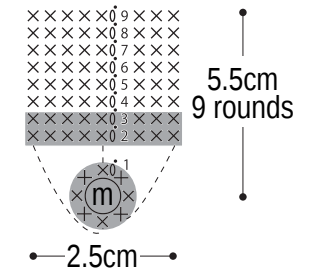

Torso (back) 4.0mm hook

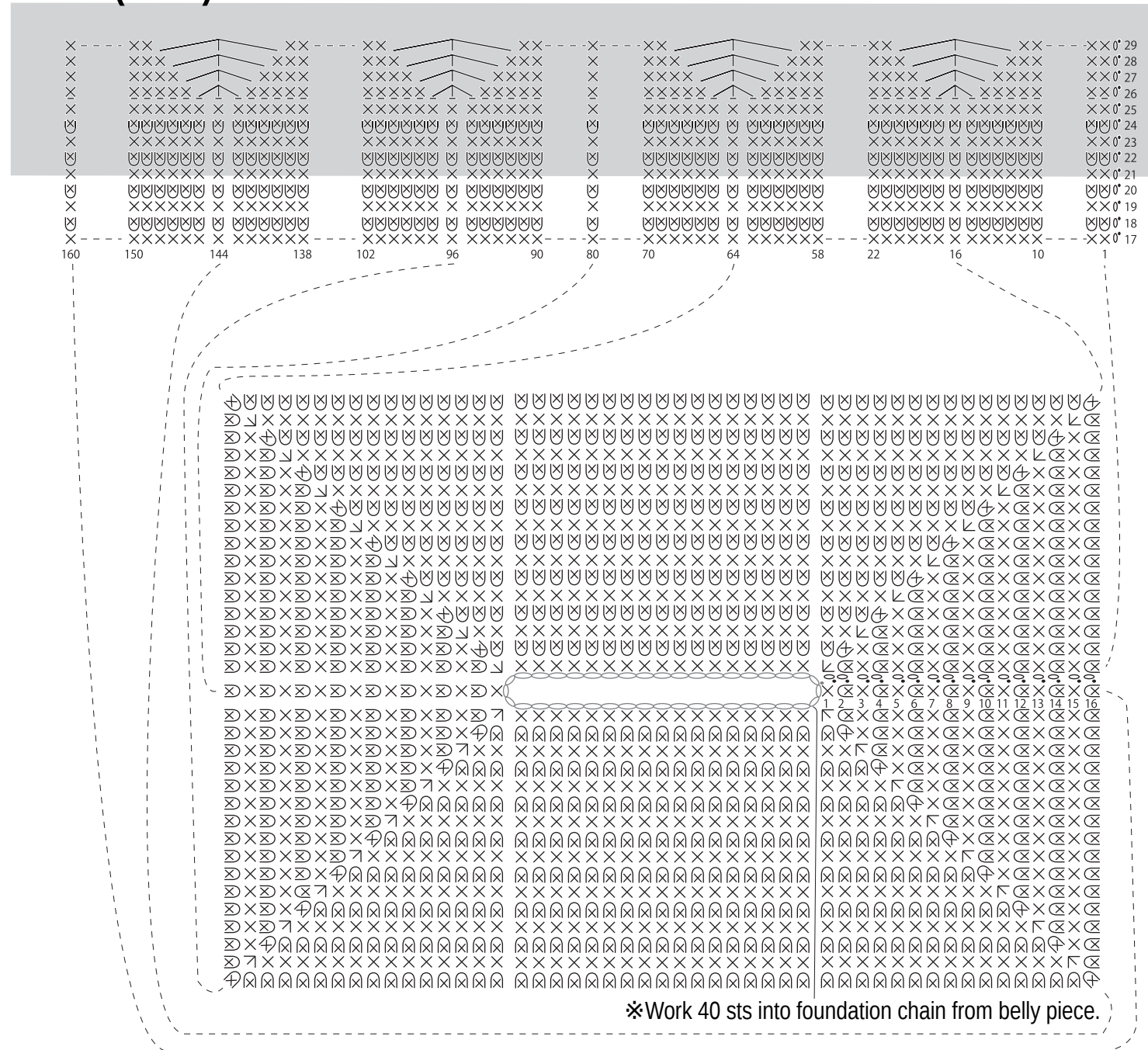

2 strands (colors 227 & 228)

※While working round 17, insert stuffing. Seam belly & back together by working sts of this round together with sts of last round of belly piece.

2 strands (colors 228 & 229)

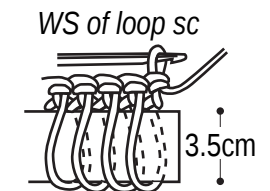

※Wrap yarn around piece of cardboard 3.5cm wide (instead of using finger) to work loop sc.

⊗ = loop sc

Use QR code on smartphone to view a video tutorial on loop sc stitch.

※To view on computer, search on the Pierrot Yarns website or YouTube channel instead.

SEARCH