

# 27-28-507K Cashmere Scarf, Cap & Corsage Set



## Suggested yarn:

- Pierrot Yarns Pure Cashmere 100 [100% cashmere; 79 yds/72m per 0.71 oz./20g skein];
  - scarf:
    - color #1 ivory, 3 skeins [45g]
    - color #9 light pink, 1 skein [small amount]
  - cap:
    - color #1 ivory, 1 skein [small amount]
    - color #9 light pink, 2 skeins [35g]
- Pierrot Yarns New Cashmere 100 [100% cashmere; 71 yds/65m per 0.71 oz./20g skein];
  - corsage:
    - color #501 ivory, 1 skein [8g]
    - color #503 fraise (strawberry), 1 skein [8g]

## Tools/Notions:

- 2.5mm (approx. US B or C) and 5.0mm (US H) crochet hooks or sizes necessary to achieve gauge

## Finished measurements:

- scarf: width 12cm/4.72", length 134cm/52.76"
- head circumference (cap): 44cm/17.32"
- corsage diameter: 8.5cm/3.35"

## Gauge (10cm/4" square):

- scarf: pattern stitch: 32.5 sts and 9.5 rows
- cap: pattern stitch: 24.5 sts and 11 rows

*Gauge may vary according to individual crochet style. Change hook size if necessary to achieve gauge. Alternatively, rework pattern with your own gauge measurements.*

## Crochet Tips

**Scarf:** Beginning at center of scarf, chain to create foundation row. Work 55 rows in pattern stitch. Work second half of scarf by working new stitches into foundation row of first half; work as for first half. For each end of scarf, work 2 rows in contrasting color as indicated on schematic. Attach fringe in 15 places on each end of scarf.

**Corsage:** Create magic ring. ch1 as turning post for round 1, then repeat \*sc, ch3, dc, ch3\* from \* to \* around, working a slip stitch into first sc of round to finish the round. Work back post sc (bpsc) on round 2. Refer to chart for round 3. Work round 4 and center of flower (embellishments) in different colors as indicated.

❖ **Note:** entire corsage worked with 2 strands of yarn held together.

## Abbreviations:

bpsc = back post single crochet (US)

ch = chain

dc = double crochet (US)

m = magic ring

rem = remaining

sc = single crochet (US)

### Hat instructions

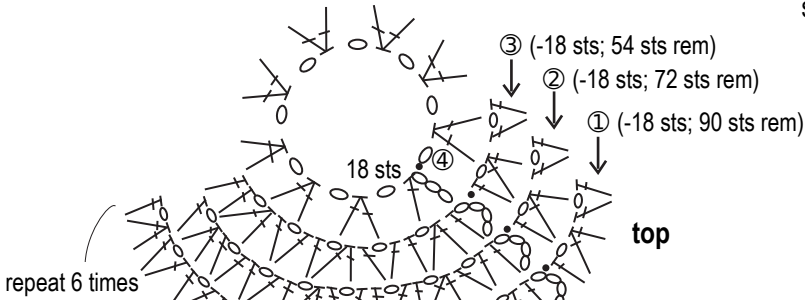

### Hat

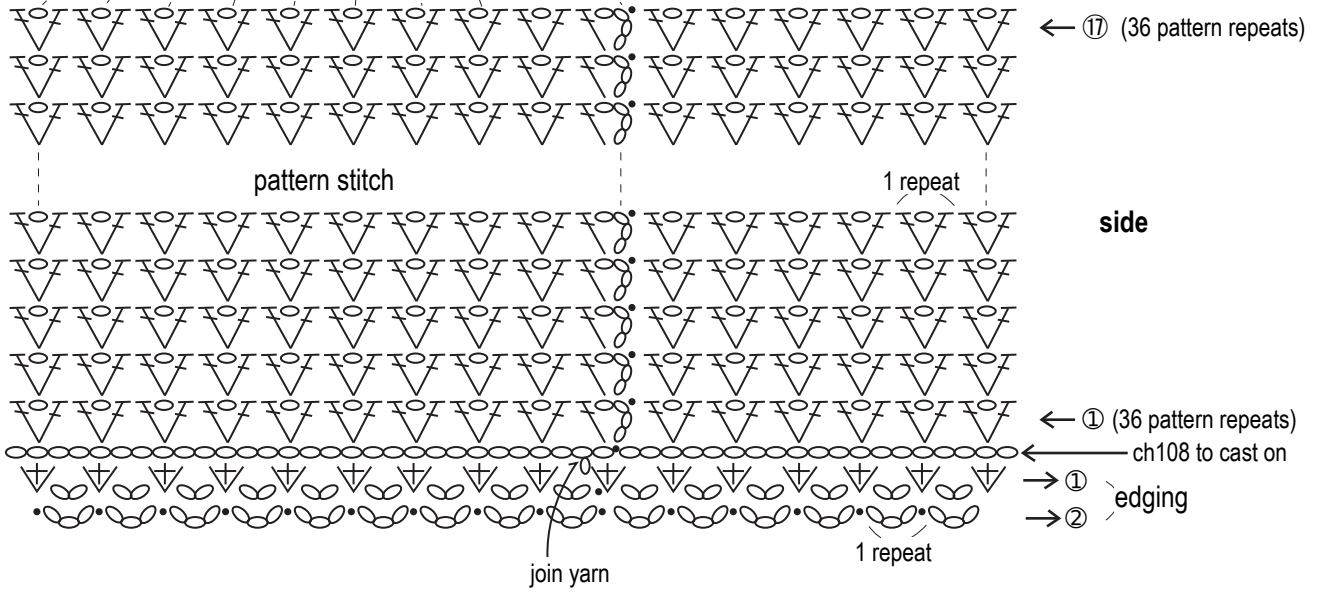
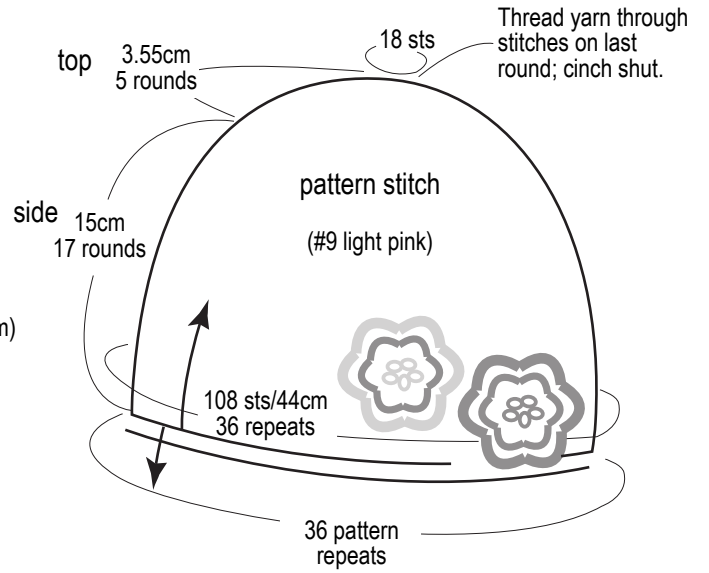

## Corsage

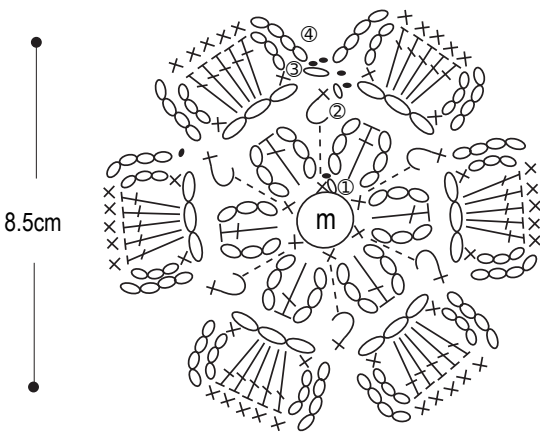

⌘ = bpsc

(Insert hook from back around post of stitch in round 1; draw up a loop and work sc stitch.)

## Corsage finishing

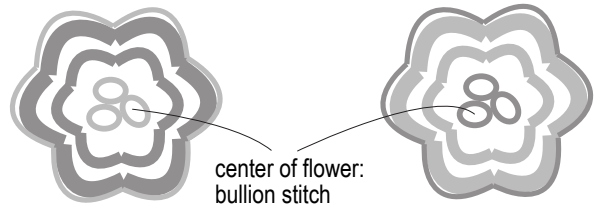

center of flower:  
bullion stitch  
(wrap 8 times)

■ = #503 fraise  
■ = #501 ivory

## Scarf instructions

### Scarf

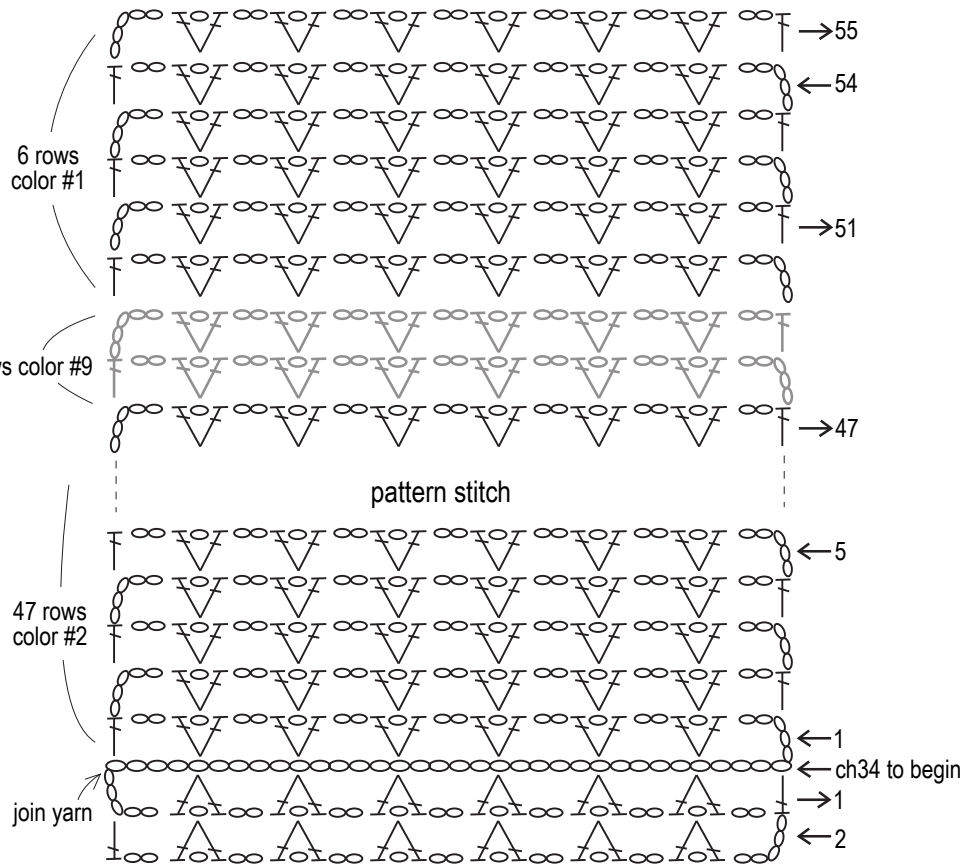
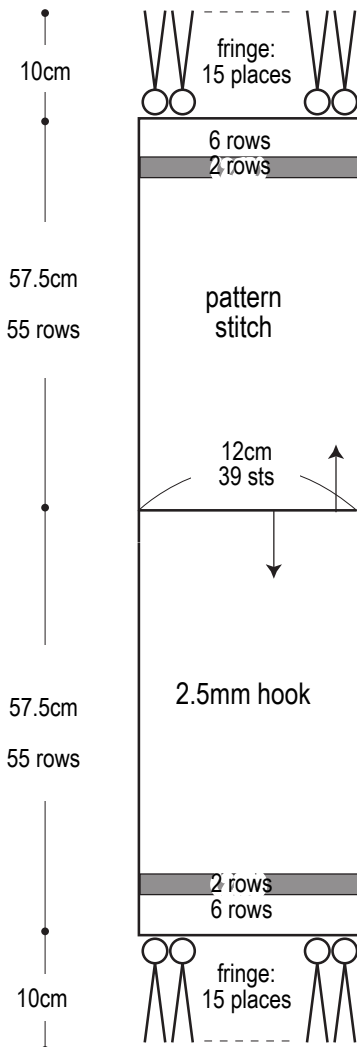

★ Make fringe by folding 5 strands of yarn (each 23cm long) in half. Attach in 15 places on each end of scarf.

