

# Amikomo-A Zakka Wool Scarf & Hat



## Suggested yarn:

- Pierrot Yarns Zakka Wool [100% wool; 75 yds/69m per 1.41 oz./40g skein];
  - hat:
    - color #12 deep Nile green, 3 skeins [90g]
    - color #2 yellow beige, 1 skein [15g]
  - scarf:
    - color #2 yellow beige, 3 skeins [110g]
    - color #12 deep Nile green, 1 skein [15g]

## Tools/Notions:

- 3.5mm (US E) crochet hook or size necessary to achieve gauge

## Finished measurements:

Refer to schematics.

## Gauge (10cm/4" square):

No gauge information is provided in the original pattern.

*Gauge may vary according to individual crochet style. Change hook size if necessary to achieve gauge. Alternatively, rework pattern with your own gauge measurements.*

## Crochet Tips

**Hat:** Starting from brim edge, chain to create foundation round. Working in the round, work 18 rounds in pattern stitch (forming the side of the hat). Shape top of hat by decreasing on next 4 rounds. On the final round, thread yarn through remaining stitches and cinch shut. Work 2 rounds of edging in contrasting color.

**Corsage:** Create magic ring. ch1 as turning post for round 1, then repeat \*sc, ch3, dc, ch3\* from \* to \* around, working a slip stitch into first sc of round to finish the round. Work back post sc (bpsc) on round 2. Refer to chart for round 3. Work round 4 and center of flower (embellishments) in different colors as indicated.

**Scarf:** Beginning at center of scarf, chain to create foundation row. Work 54 rows in pattern stitch. Work second half of scarf by working new stitches into foundation row of first half; work 54 rows as for first half. For each end of scarf, work 2 rows in contrasting color as indicated on schematic. Attach fringe.

## Abbreviations:

bpsc = back post single crochet (US)  
ch = chain  
dc = double crochet (US)  
m = magic ring  
rem = remaining  
sc = single crochet (US)

### Hat instructions

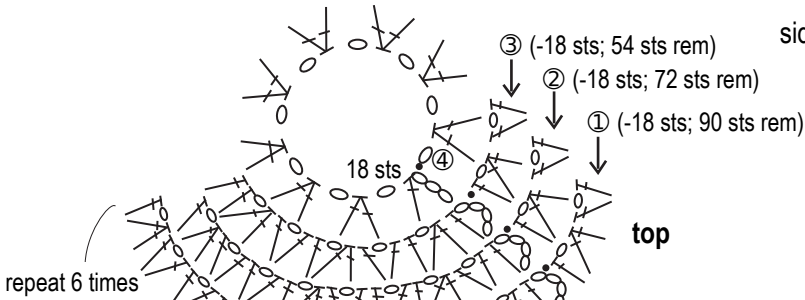

### Hat

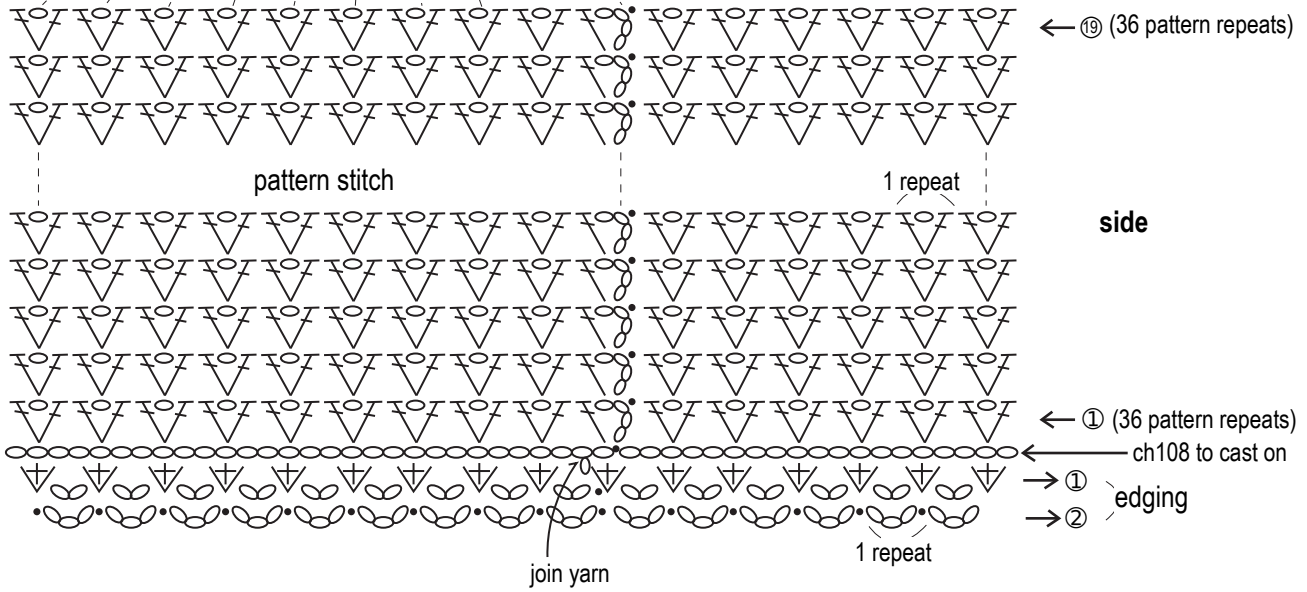
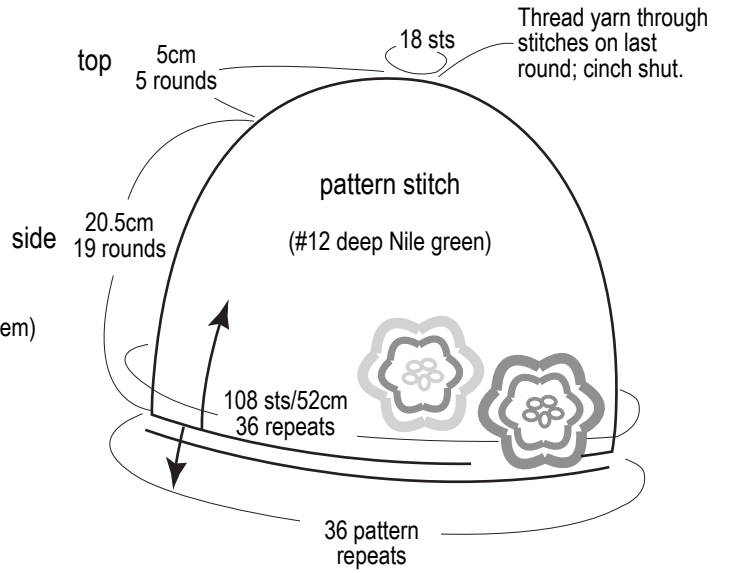

### Corsage

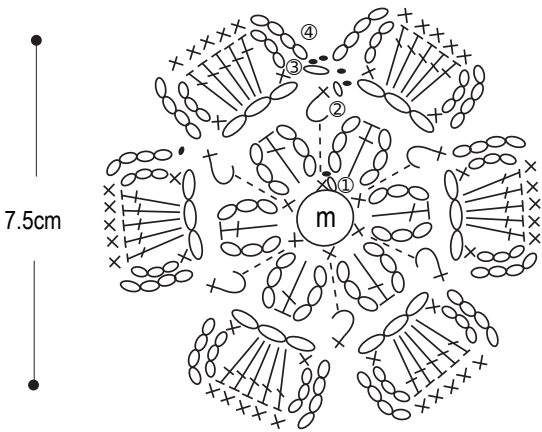

⊗ = bpsc

(Insert hook from back around post of stitch in round 1; draw up a loop and work sc stitch.)

### Corsage finishing

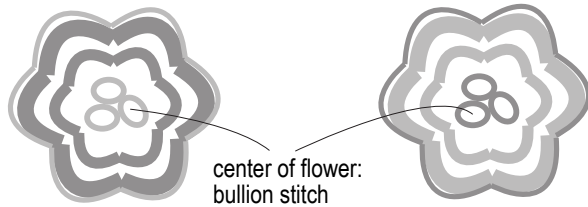

center of flower:  
bullion stitch  
(wrap 8 times)

■ = #12 deep Nile green  
■ = #2 yellow beige

### Scarf

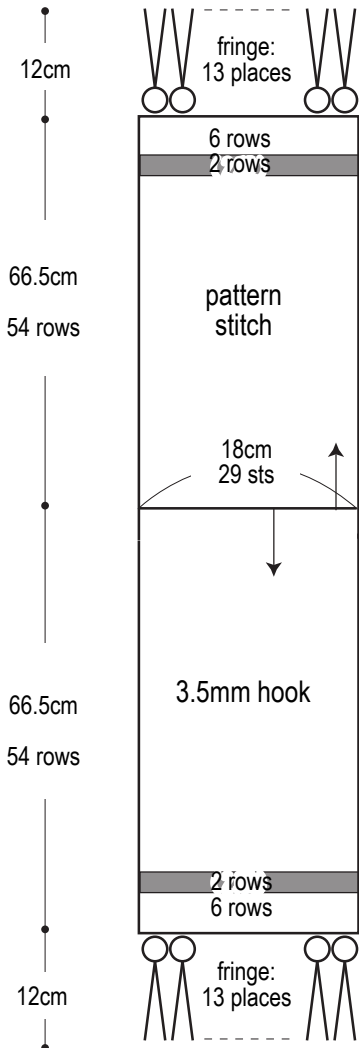

### Scarf instructions

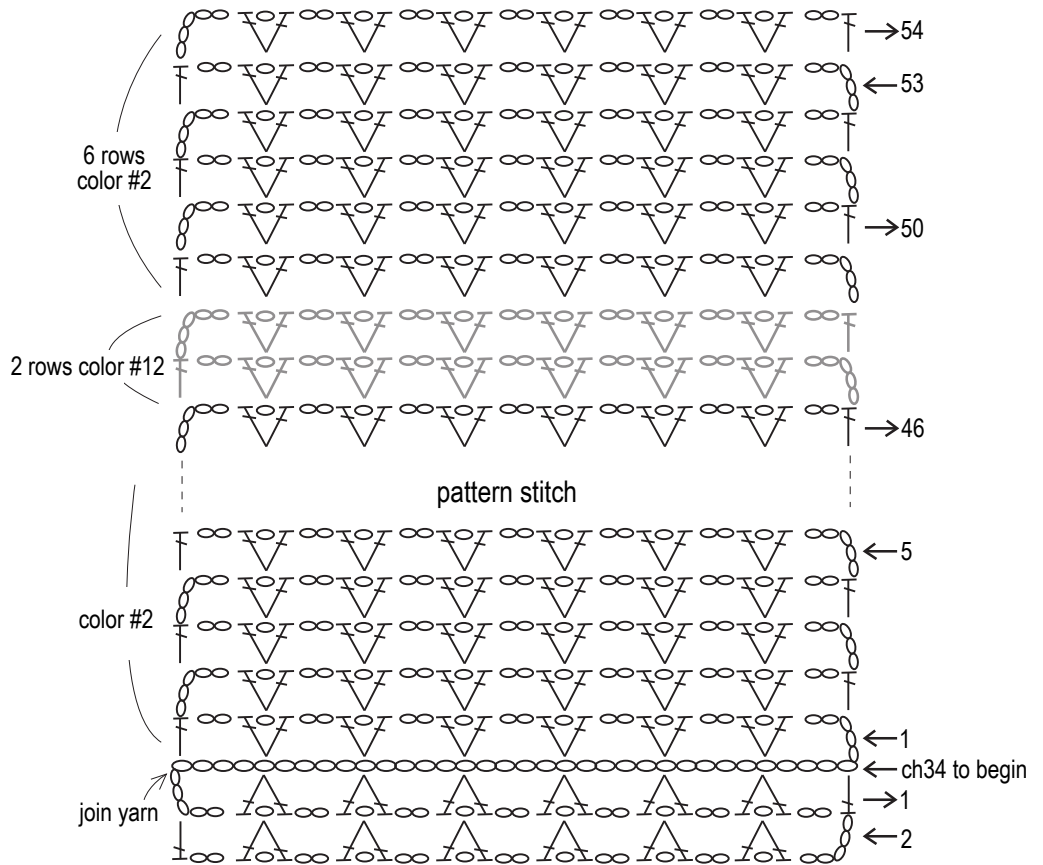

★ Make fringe by folding 5 strands of yarn (each 28cm/11" long) in half. Attach in 13 places on each end of scarf.

